

Features

- Lightweight black anodized aluminum cone
- Attractive 6-hole cast frame
- Advanced low distortion motor design
- Solid aluminum phase plug
- Rubber surround

Parameters

Impedance (Ω)	8
Re (Ω)	6.34
Le (mH) @ 1 kHz	0.83
Fs (Hz)	27.6
Qms	1.44
Qes	0.48
Qts	0.36
Mms (g)	33.8
Cms (mm/N)	0.99
Sd (cm ²)	211.2
Vd (cm ³)	147.9
BL (Tm)	8.8
VAS (liters)	61.8
XMAX (mm)	7.0
VC Diameter (mm)	38.5
SPL (dB@1W/1m)	86.2
RMS Power Handling (w)	80
Usable Frequency Range (Hz)	28 - 2,200

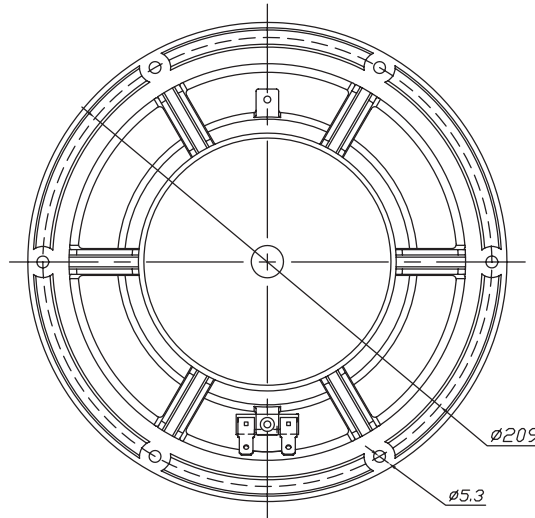
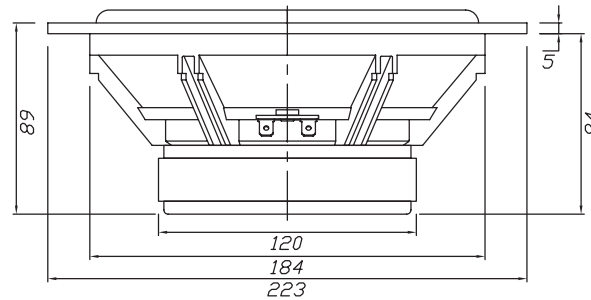

Note: All dimensions in mm.

Frequency Response

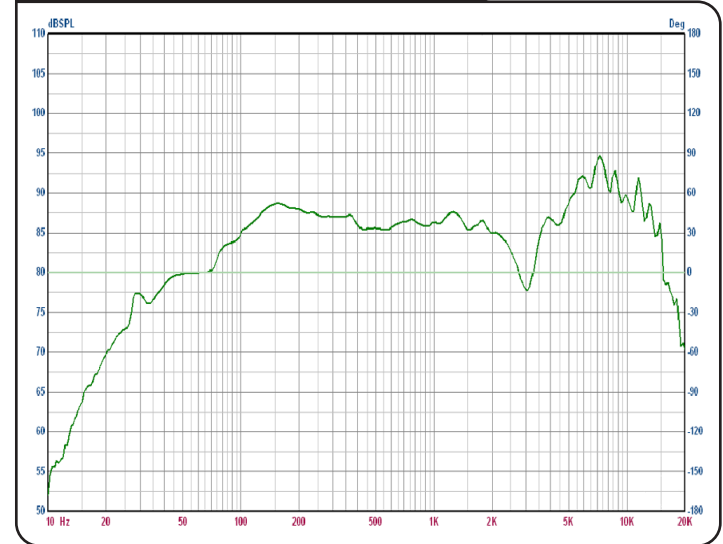

Impedance/Phase

